

## Submersible waste water pumps Discharge R 3" / DN 80. Vortex impeller, spherical clearance 50 – 65 mm.

### TP 53 V

#### Application

HOMA TP 53 series pumps are suitable for pumping drainage water or waste water. With 50 and 65 mm spherical clearance they are able to pump liquids with larger suspended solids like fibres, textiles etc. They are used for various applications in public and private sector, trade and industry.

**Z-53.3-459:** Pumps are approved by Institute of Building Technology, Berlin

**Installation:** Transportable or permanent. Models with float switch control for automatic pump operation, depending on medium level in the sump.

**Pumped medium:** Clear water and drainage water, sewage containing soft solids. Max. medium temperature: 35°C short term up to 60°C.

**Operation:** Intermittent.

#### Design

Fully submersible, compact integrated motor-pump unit consisting of:

**Pump:** Single stage centrifugal pump with horizontal discharge BSP 3" M.

**Impeller:** V = Vortex impeller for liquids containing a high level of impurities or fibrous matter and containing gas. Spherical: clearance 50 up to 65 mm.

**Motor:** Fully submersible, pressure tight electric motor. Insulation class F. Degree of protection IP 68. Thermal sensors embedded in the winding on request (standard with model Ex).

**Cable:** H07 RN - F4 G 1,5

**Model Ex.:** H07 RN - F(Plus)7 G 1,5

**Shaft/Bearing:** Large diameter stainless steel rotor shaft, pre-lubricated bearings.

**Seals:** Combination of mechanical seals (silicon-carbide/silicon-carbide) in a separate oil chamber. Models up to 1,6 kW/2-pole with mechanical seal and lip seal. Oil inspection from outside.

**Explosion protection:** All models available with explosion proof motors according to EEx d II BT4.

Z-53.3-459



#### Performance

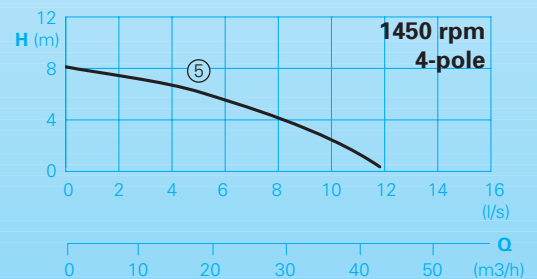
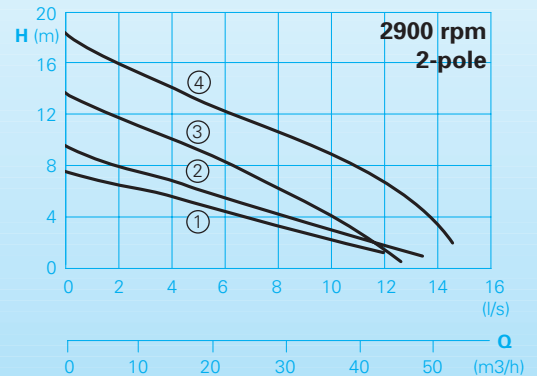

#### Technical Data

Curve No.	Pump type	Motor- input P <sub>1</sub> (kW)	Motor- output P <sub>2</sub> (kW)	Voltage 50 Hz (V)	Speed (rpm)	Nominal current (A)	Spherical clearance (mm)	Weight (kg) Standard model	Weight (kg) Ex
①	TP53 V17/2W (A)(Ex)	1,6	1,2	230-240/1Ph	2900	7,6	65	27	32
②	TP53 V17/2 D (A)(Ex)	1,6	1,2	400-415/3Ph	2900	2,9	65	27	32
③	TP53 V26/2D (A)(Ex)	2,6	2,1	400-415/3Ph	2900	4,5	50	40	40
④	TP53 V40/2D (A)(Ex)	4,0	3,4	400-415/3Ph	2900	6,6	50	45	45
⑤	TP53 V13/4D (A)(Ex)	1,3	1,0	400-415/3Ph	1450	2,6	50	40	40

Discharge: BSP 3" M

Model A: With automatic level control

HOMA-Nivomatik

Model Ex: Explosion proof

#### Materials:

Motor housing, pump housing	Cast iron GG 25
Impeller	Cast iron GG 25
Mechanical seal	Silicon-carbide
Rotor shaft, screws	Stainless steel
Seal kit	Perbonane

#### Equipment supplied

Pumps with base stand, without auto-coupling (see accessories):

**Model W:** (230-240 V/1 Ph): 10 m of cable. Attention: The pump requires a capacitor for operation, which is integrated in the control box (see accessories).

**Model D:** (400-415 V/3Ph): 10 m of cable.

**Model A:** With additional automatic level control, control box with overload protection, manual-auto switch and 10 m of cable. 1Ph-model with integrated capacitor. Model Ex with intrinsically safe relay.

## Installations and Dimensions

### Free standing pump with base stand

#### TP 53 V 17...

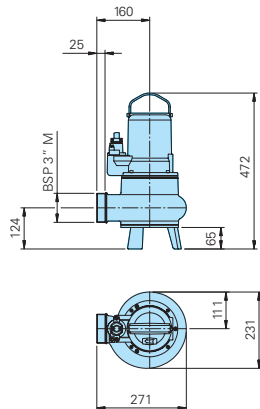

#### TP 53 V 26..., TP 50 V 13...

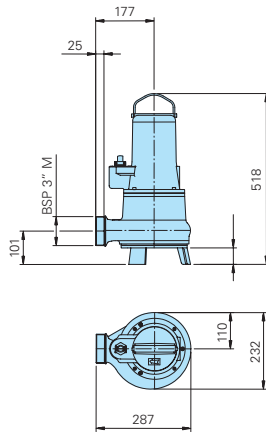

#### TP 53 V 40...

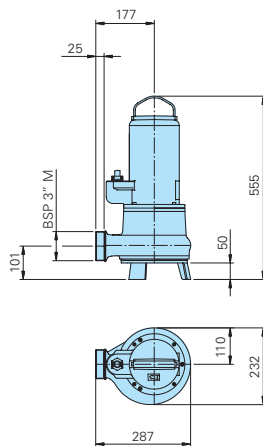

Typ	B	C	D	E	F	G
TP 53 V 17...	537	629	446	66	231	689
TP 53 V 26	607	645	462	89	232	690
TP 53 V 40	644	645	462	89	232	690

### Wet well installation with auto-coupling system.

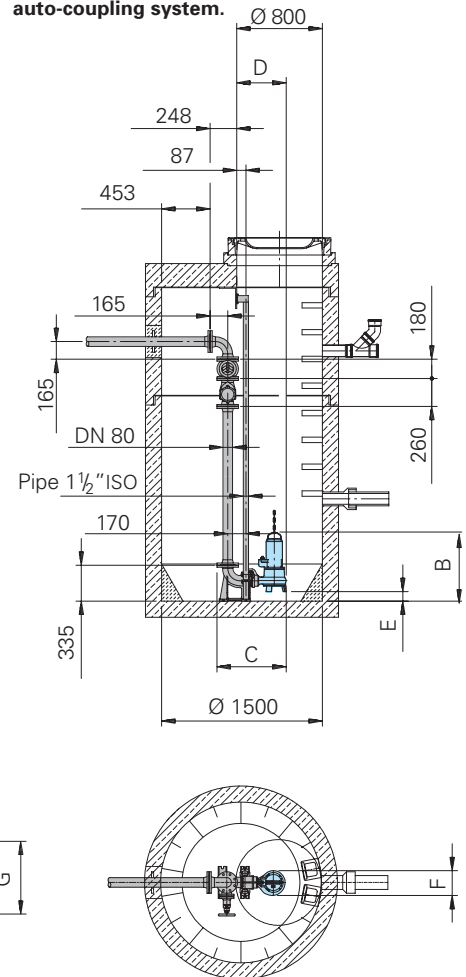

all dimensions in mm

### Accessories

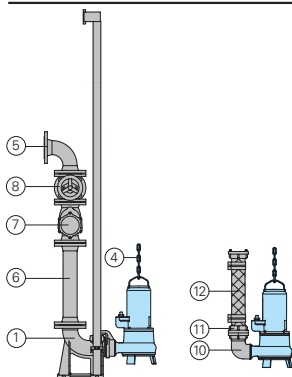

Part Description	Dimension	Part No.
① Cast iron autocoupling system with auto-coupling with flange DN 80 and upper slide rail bracket BSP 1 1/2"		
- Type KK80/R 3"		
with flanged pump coupling	BSP 3" F	8604035
- Type KK 80/80		
with flanged pump coupling	DN 80	8604025
Threaded flange	DN 80/BSP3"F	2215080

Part Description	Dimension	Part No.
⑤ 90° flanged elbow	DN 80 DN 100	2153302 2153303
Flanged Y-piece for twin pump arrangement, horizontal	3x DN 80 DN 80/80/100	2160006 2160008
discharge (vertical discharge on request)	3x DN 100	2160010
④ Flanged discharge pipe with gasket and fixing bolts, per m	DN 80 DN 100	2152081 2152201
Discharge pipe, per additional m	DN 80 DN 100	2150080 2150100
Flanged reducer		On request
⑦ Flanged swing check valve with gasket and fixing bolts	DN 80 DN 100	2212807 2212809
⑧ Flanged gate valve with gasket and fixing bolts	DN 80 DN 100	2216080 2216100
⑩ 90° elbow	BSP3"F/M	2111805
Flanged 90° elbow	DN 80	2153302
Threaded flange	DN 80/BSP3"F	2215080
⑪ STORZ-fixed coupling	B-3"F	2010602
STORZ-hose coupling	B-75 mm dia.	2013502

Part Description	Dimension	Part No.
⑫ Reinforced hose with 2 B-size half couplings, 75 mm dia.	length 2 m length 3 m length 5 m	2161042 2161043 2161045
Flanged reinforced hose 90 mm dia., DN 80	length 2 m length 3 m length 5 m	2161032 2161033 2161035
Reinforced hose, per m	75 mm dia. 90 mm dia.	2632075 2632090
Flanged spigot DN 80	90 mm dia.	2171014
Hose band	85/20 92/20	2308520 2309220
○ Synthetic pressure hose with rubber lining and couplings, B-75 mm dia.	length 10 m length 15 m length 20 m length 30 m	2611210 2611215 2611220 2611230
Reinforced hose, per m	75 mm dia.	2632075
Hose bands	85/20	2308520
○ Control box for pumps without level control, with overload protection, on-off switch		
- for 1 Ph-pumps (incl. capacitor) stand. model TP53V17/2W		1918113
- for 1 Ph-pumps (incl. capacitor) Model Ex TP53V17/2WEx		1945030
- for 3 Ph-pumps standard		
Nominal current	2,5 up to 4,0 A 4,1 up to 6,3 A 6,4 up to 10,0 A	1926090 1926095 1926100
- for 3 Ph-pumps Model Ex		
Nominal current	2,5 up to 4,0 A 4,1 up to 6,0 A 6,1 up to 9,0 A	1926220 1926225 1926230
○ Control panel for single or twin pump stations for automatic operation		On request



HOMA Pumpenfabrik GmbH  
Postfach 22 63, D-53814 Neunk.-Seelscheid  
Tel. ++49(0)22 47/702-0, Fax ++49(0)22 47/702-44  
e-mail: info@homa-pumpen.de  
www.homapumps.com